

— TANGENCIAS A CURVAS CÓNICAS —

{
 ELIPSES
 PARÁBOLAS
 HIPÉRBOLAS.

- PUNTO DE LA CURVA.
- PUNTO EXTERIOR.
- DIRECCIÓN

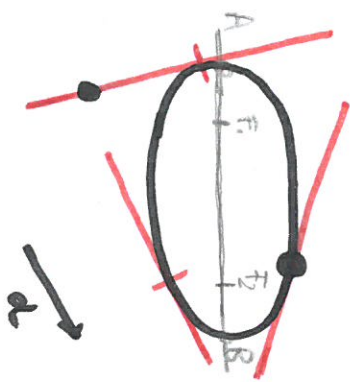
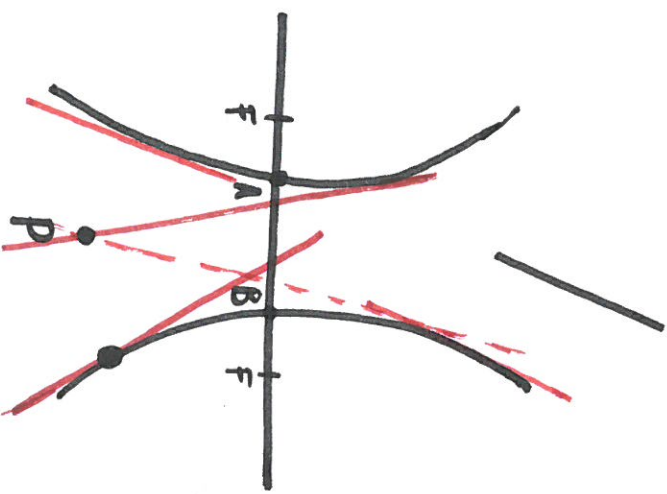
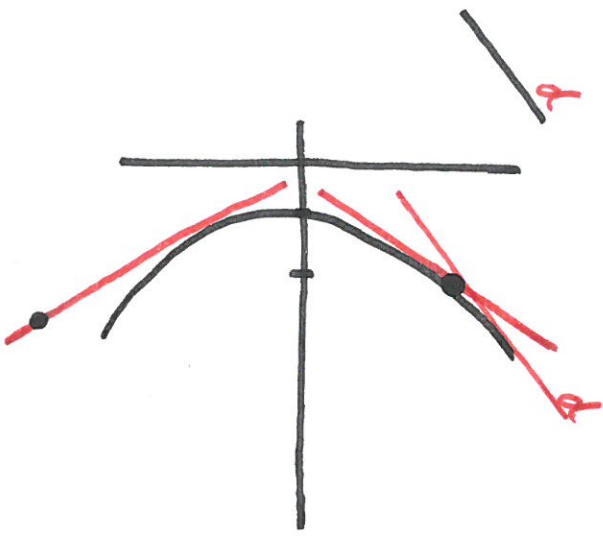

ELIPSES

RECTAS TANGENTES A UNA

— ELLIPSE —

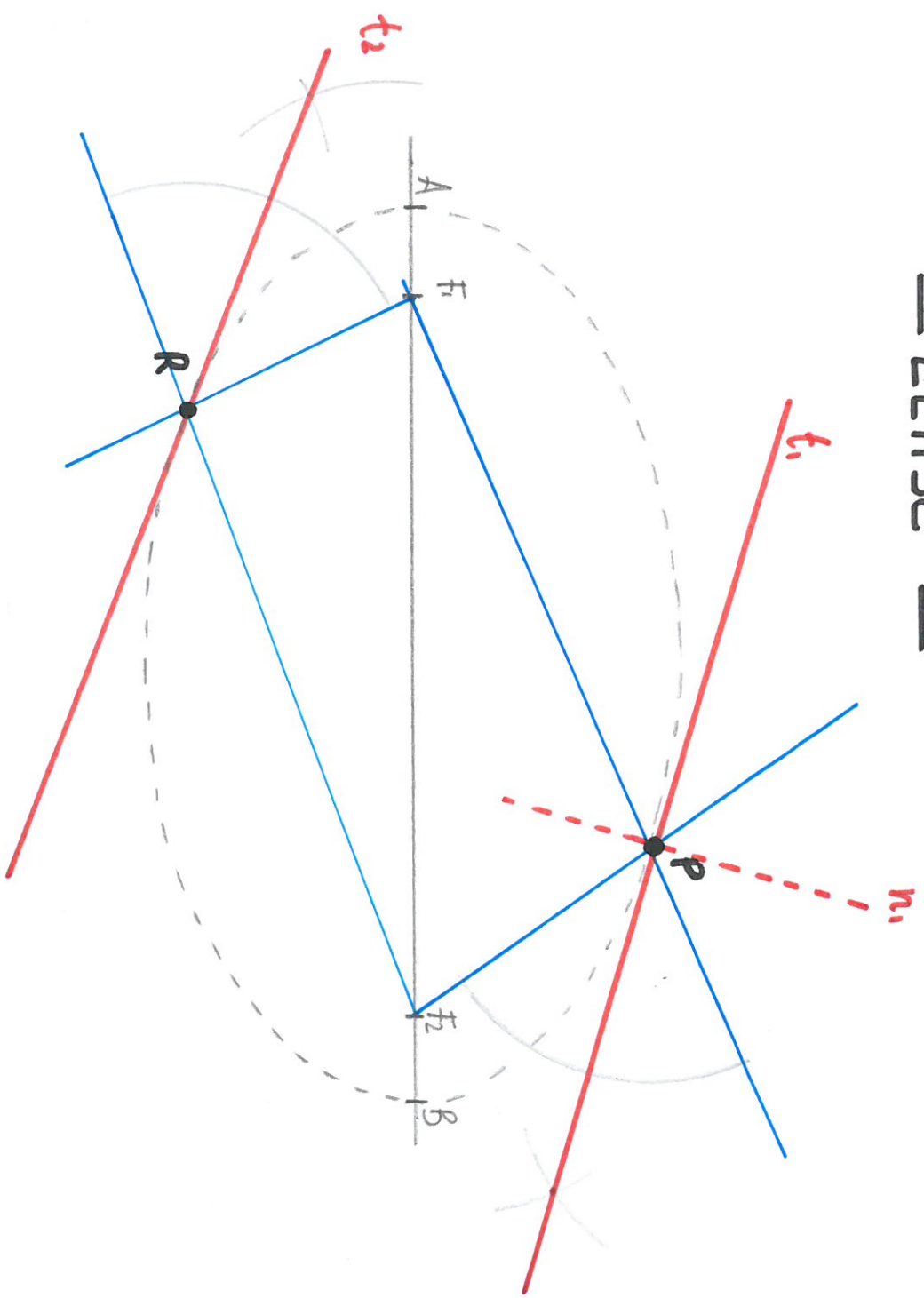

RECTAS TANGENTES DESDE UN PUNTO EXTERIOR - [1]

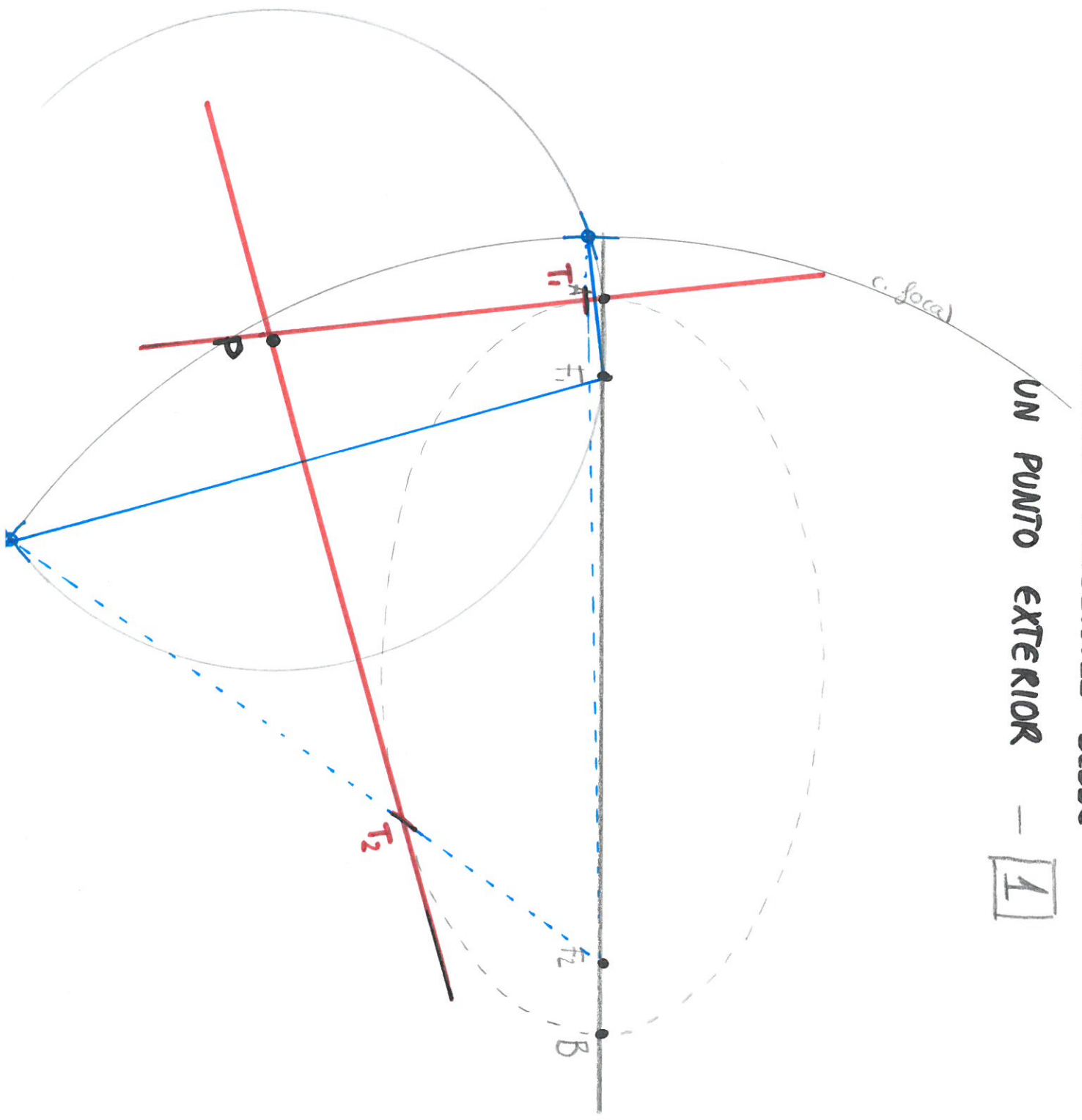

T. DESDE UN PUNTO EXTERIOR

2

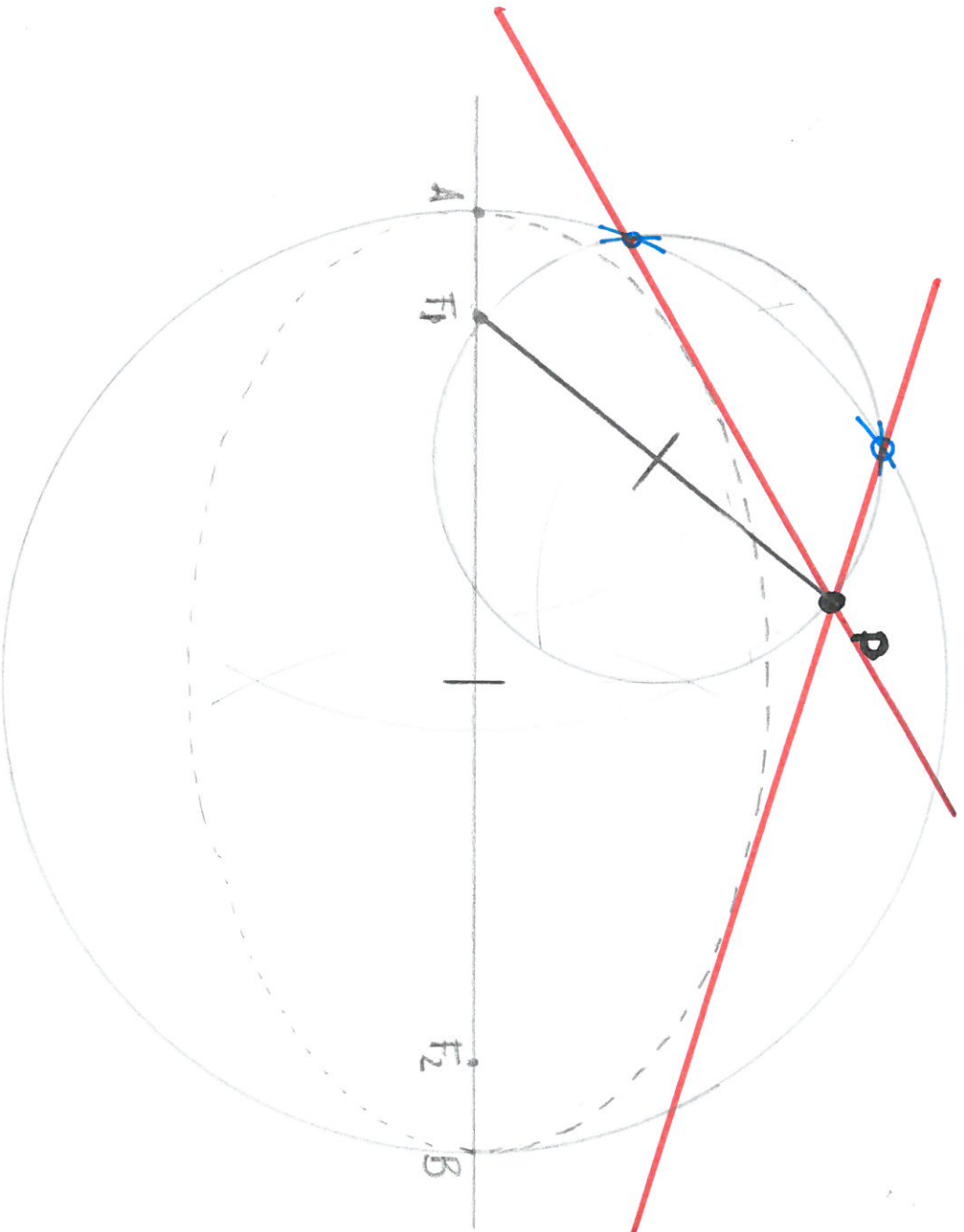

3

- Tg. DADA UNA DIRECCIÓN -

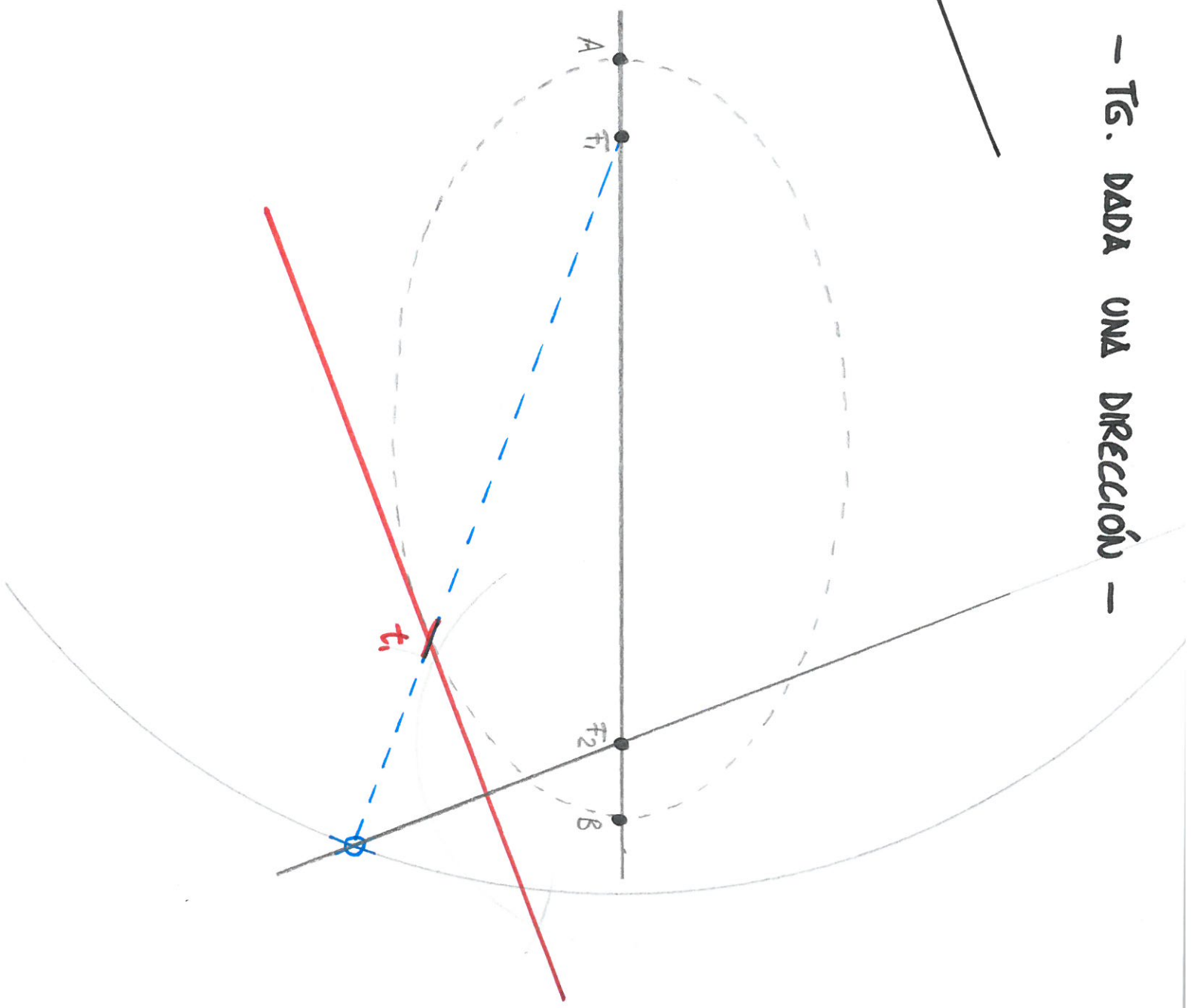

DADA UNA DIRECCIÓN (parte II)

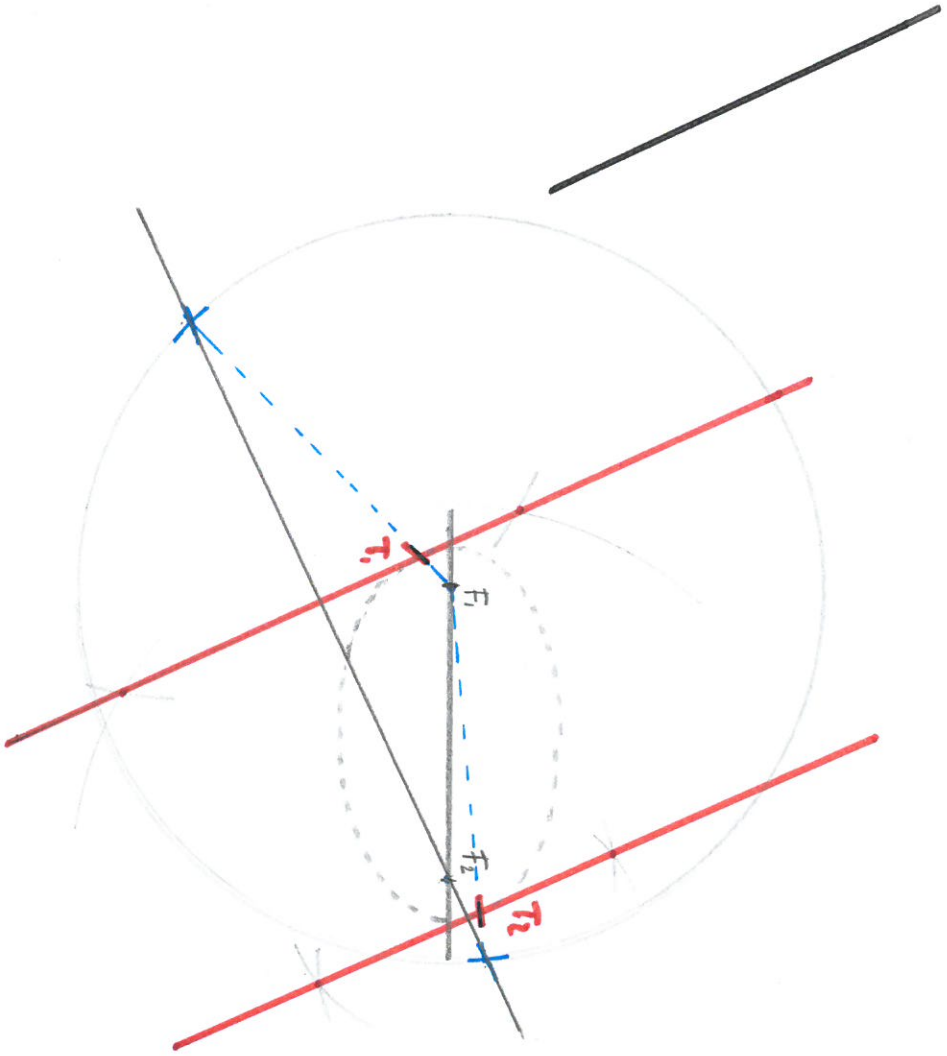

— CONSTRUCCIONES —

1) EJE AB
TANGENTE

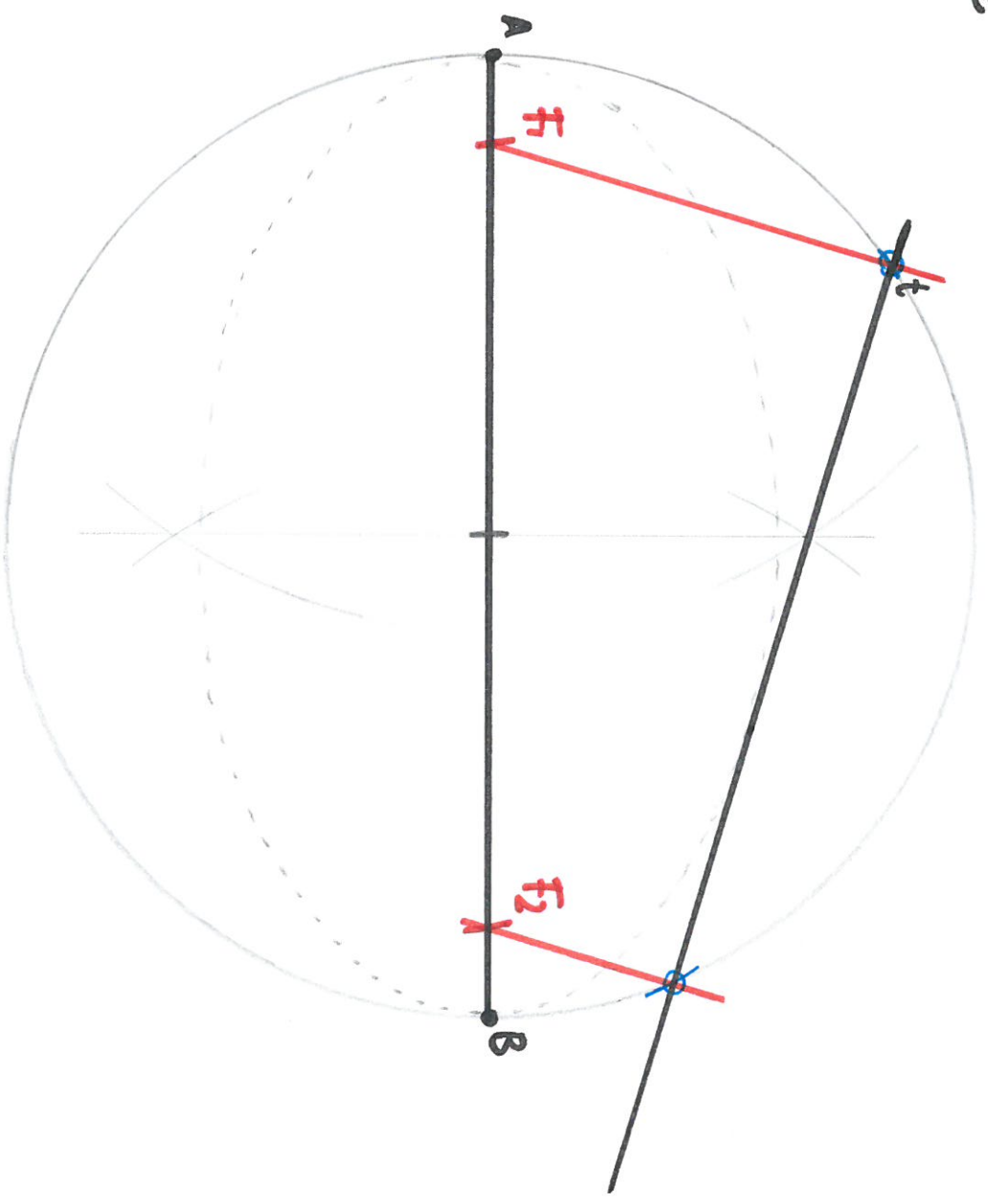

2) FOCOS TANGENTE

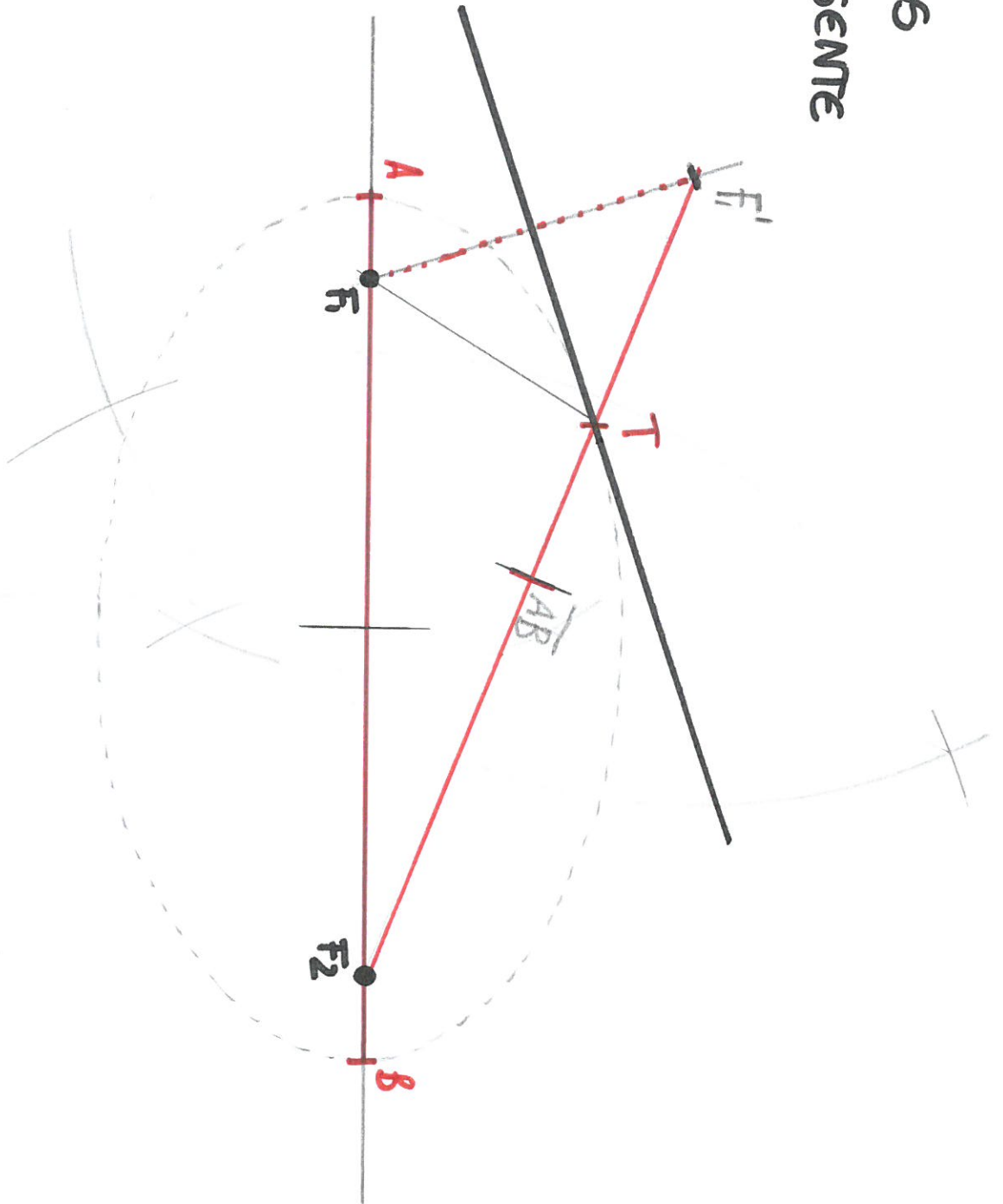

3) VÉRTICE

FOCO

TANGENTE

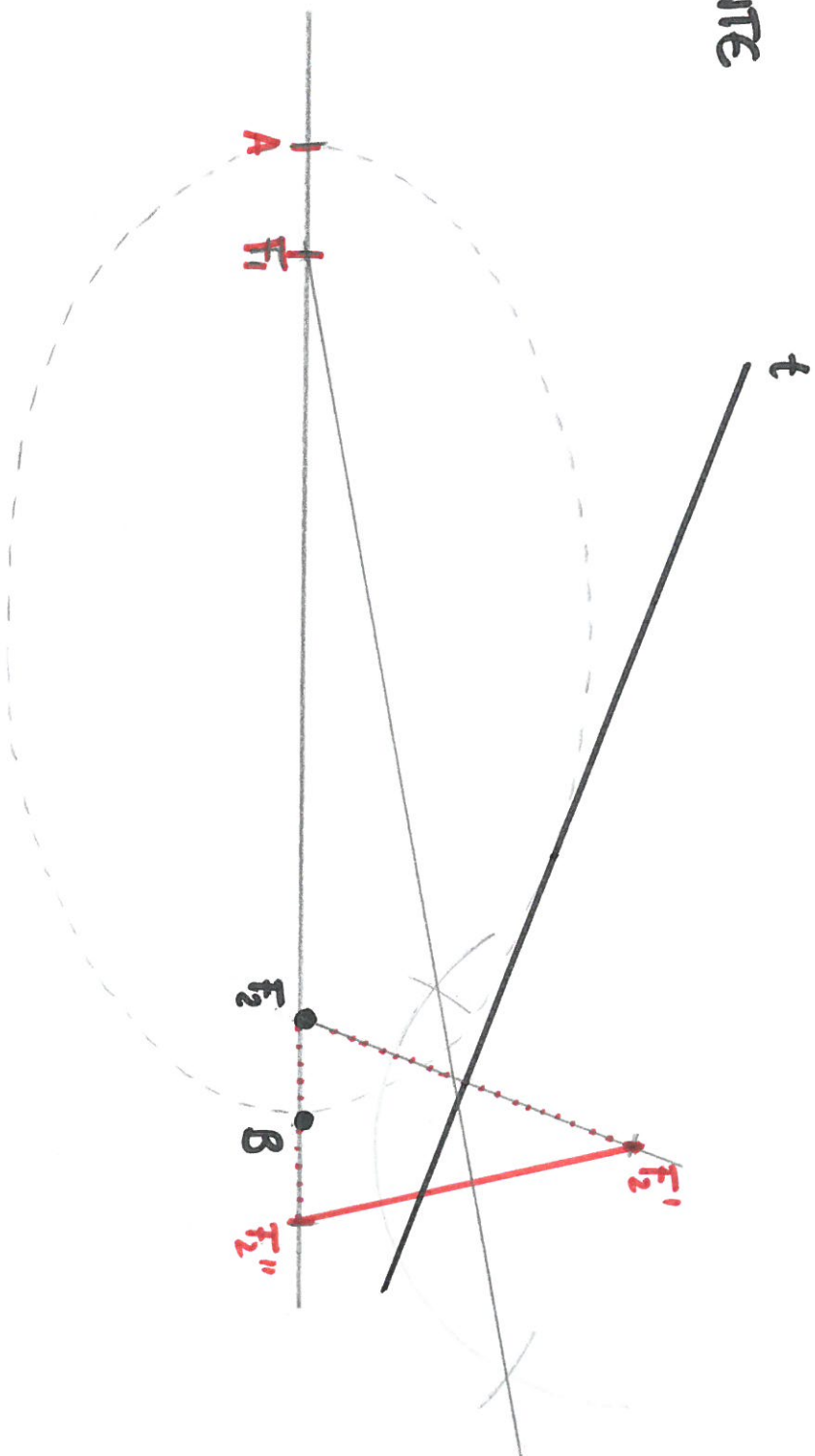

4) Foco.

3 TANGENTES

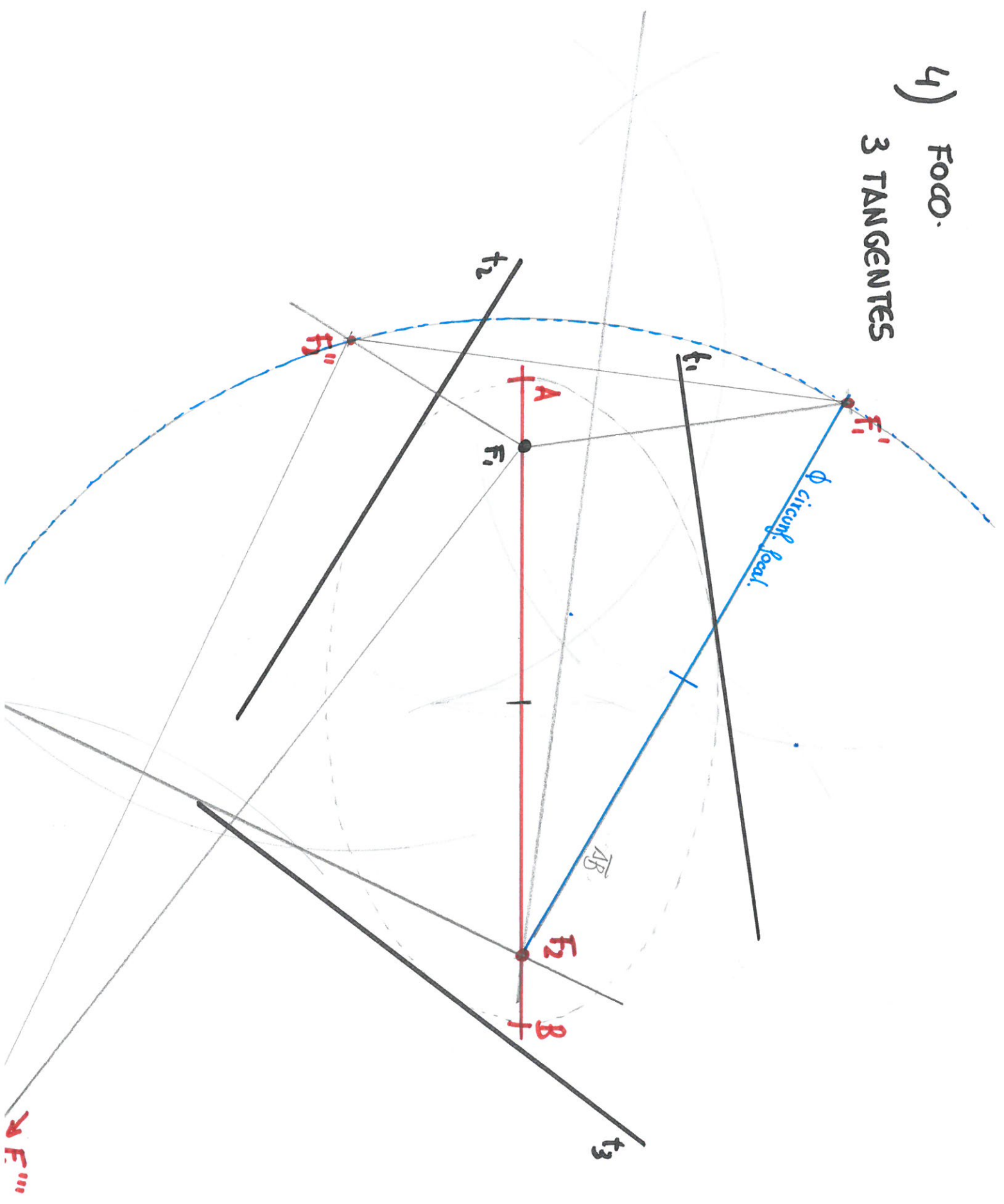

5) FOCUS

DIST. FOCAL

2 TANGENTES

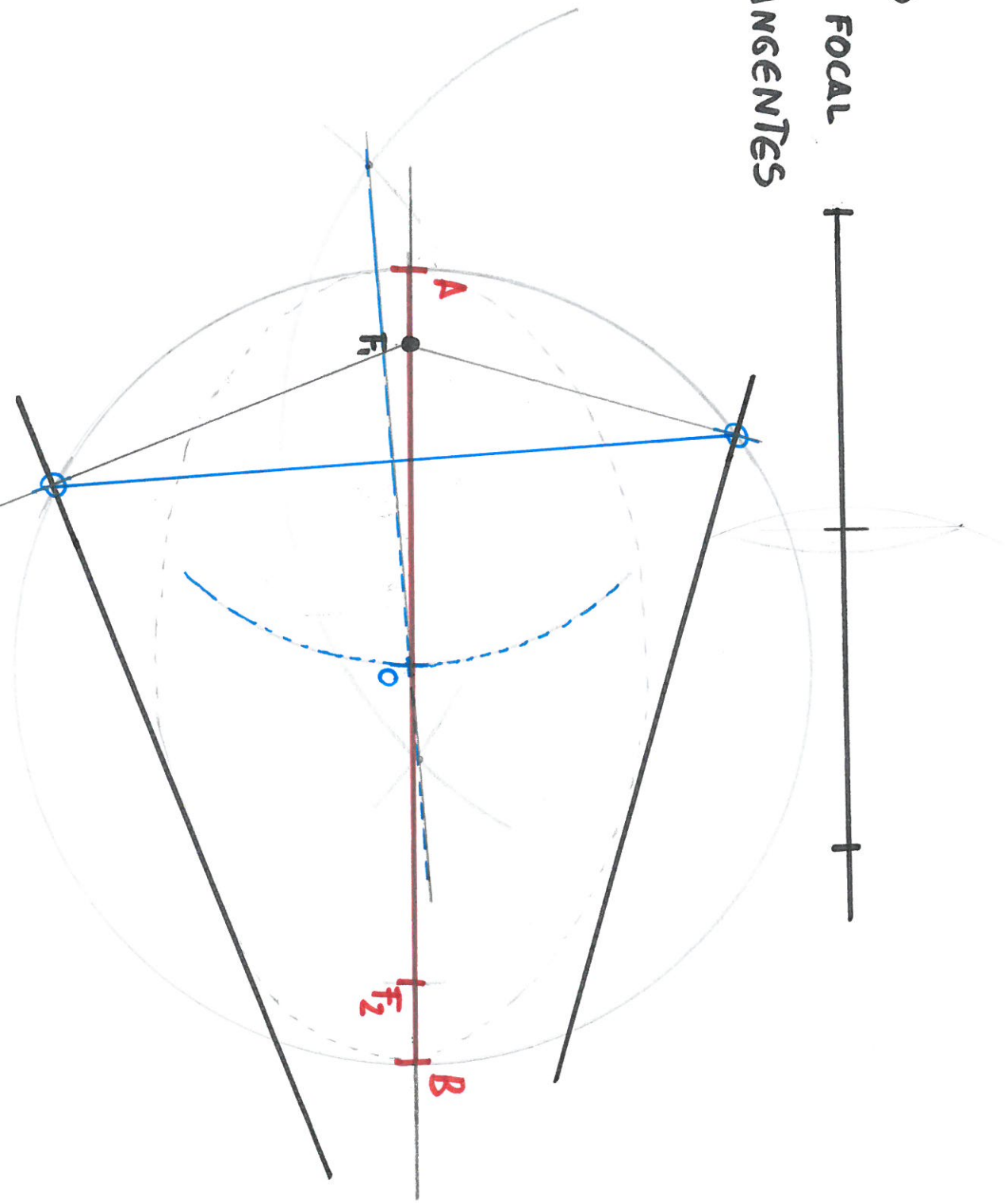

PARÁBOLAS

RECTA TANGENTE POR UN PUNTO DADO
— PARÁBOLA [1]

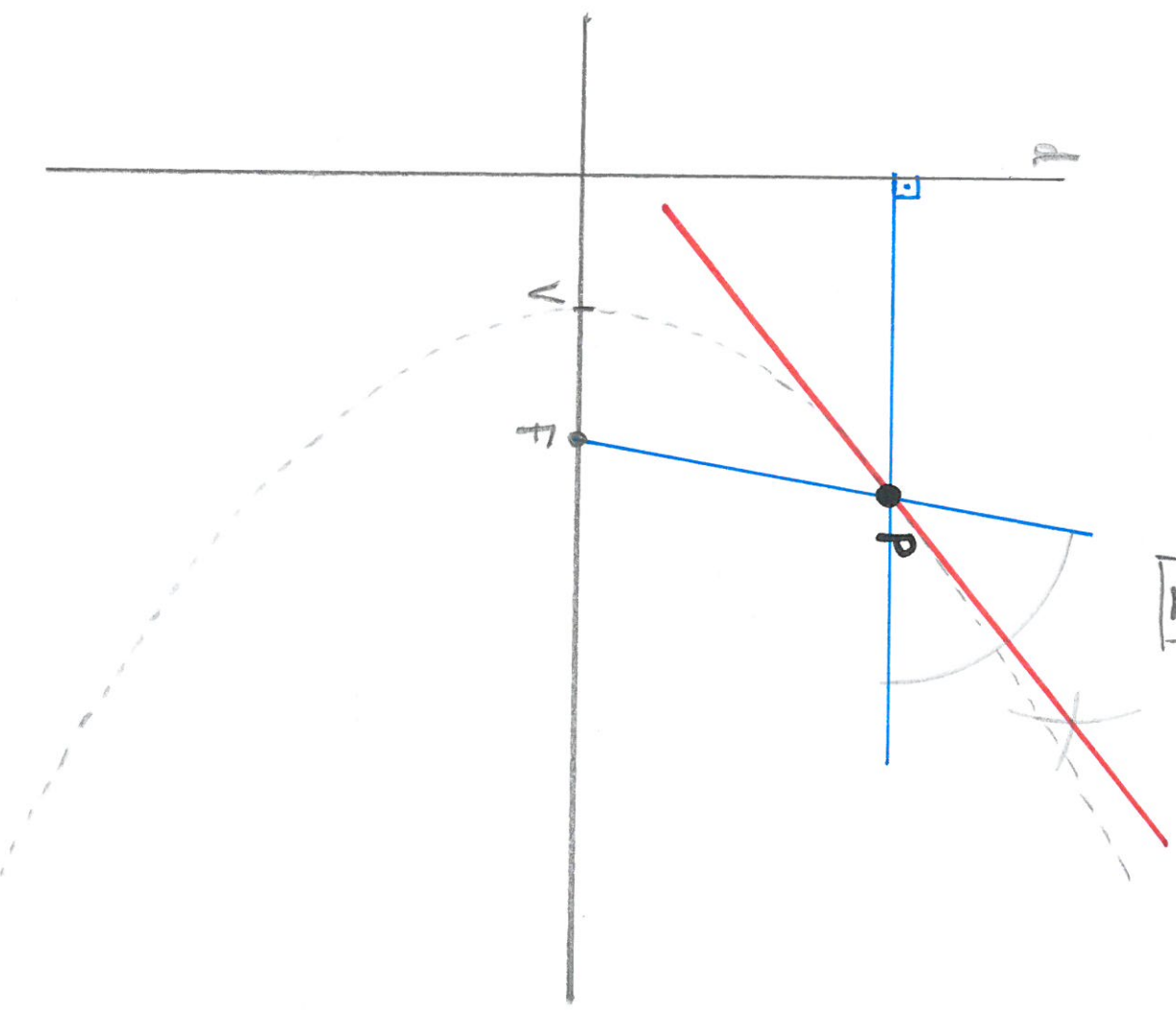

TG. POR UN PUNTO DADO — PARÁBOLA

2

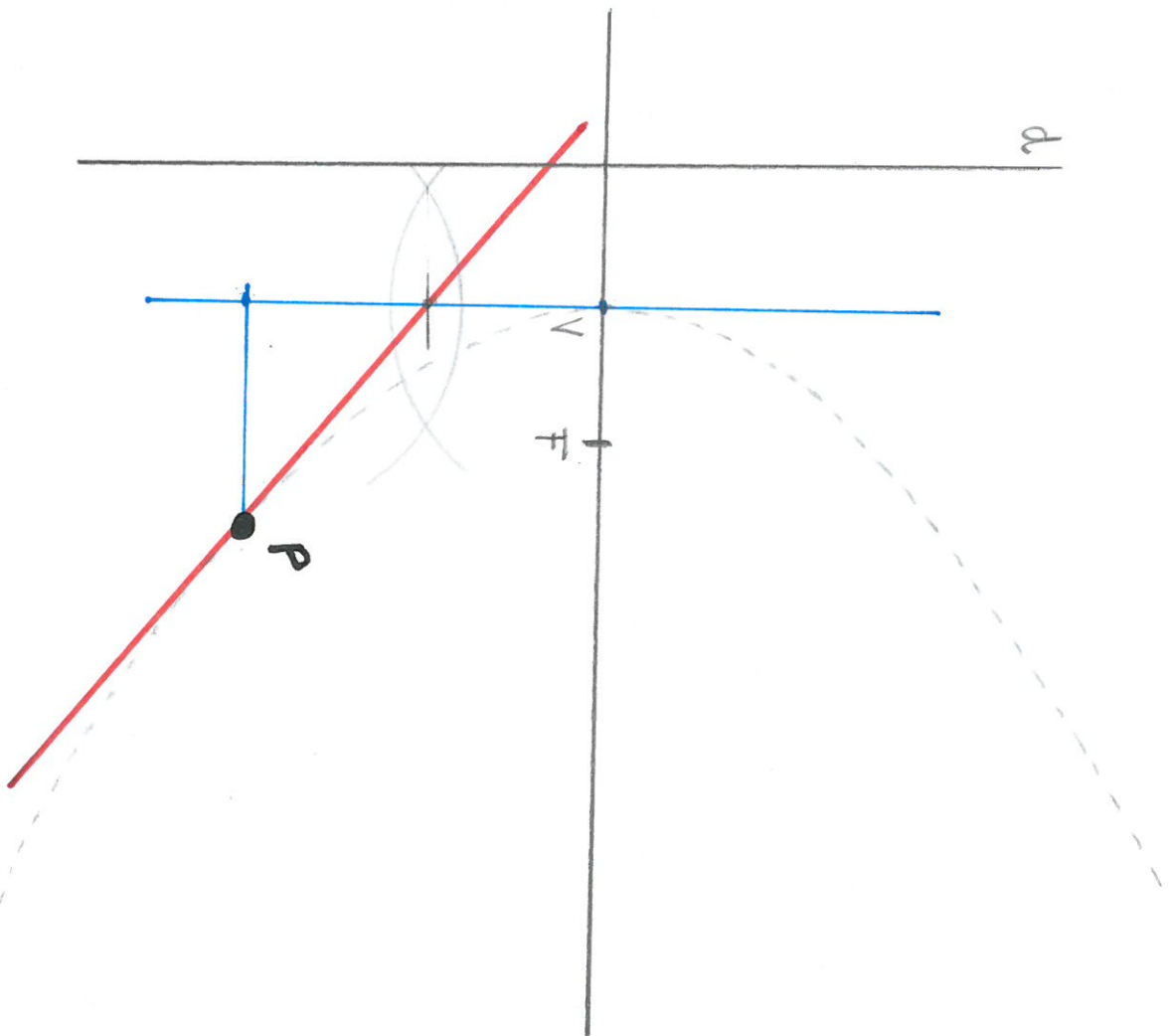

2

TANGENTE DADA UNA DIRECCIÓN

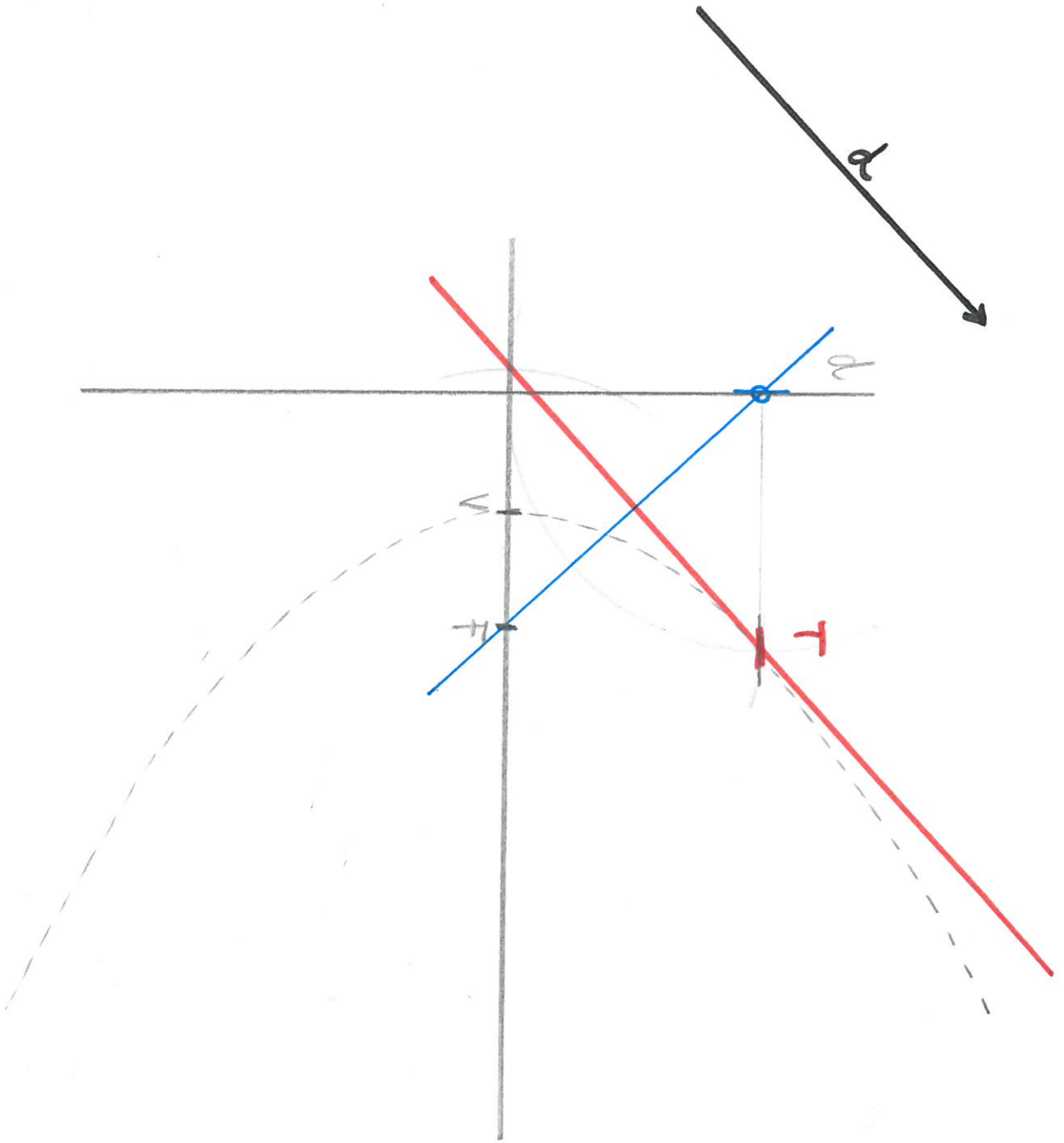

- CONSTRUCCIONES CON TANGENTES -

1) DIRECTRIZ

2 TANGENTES

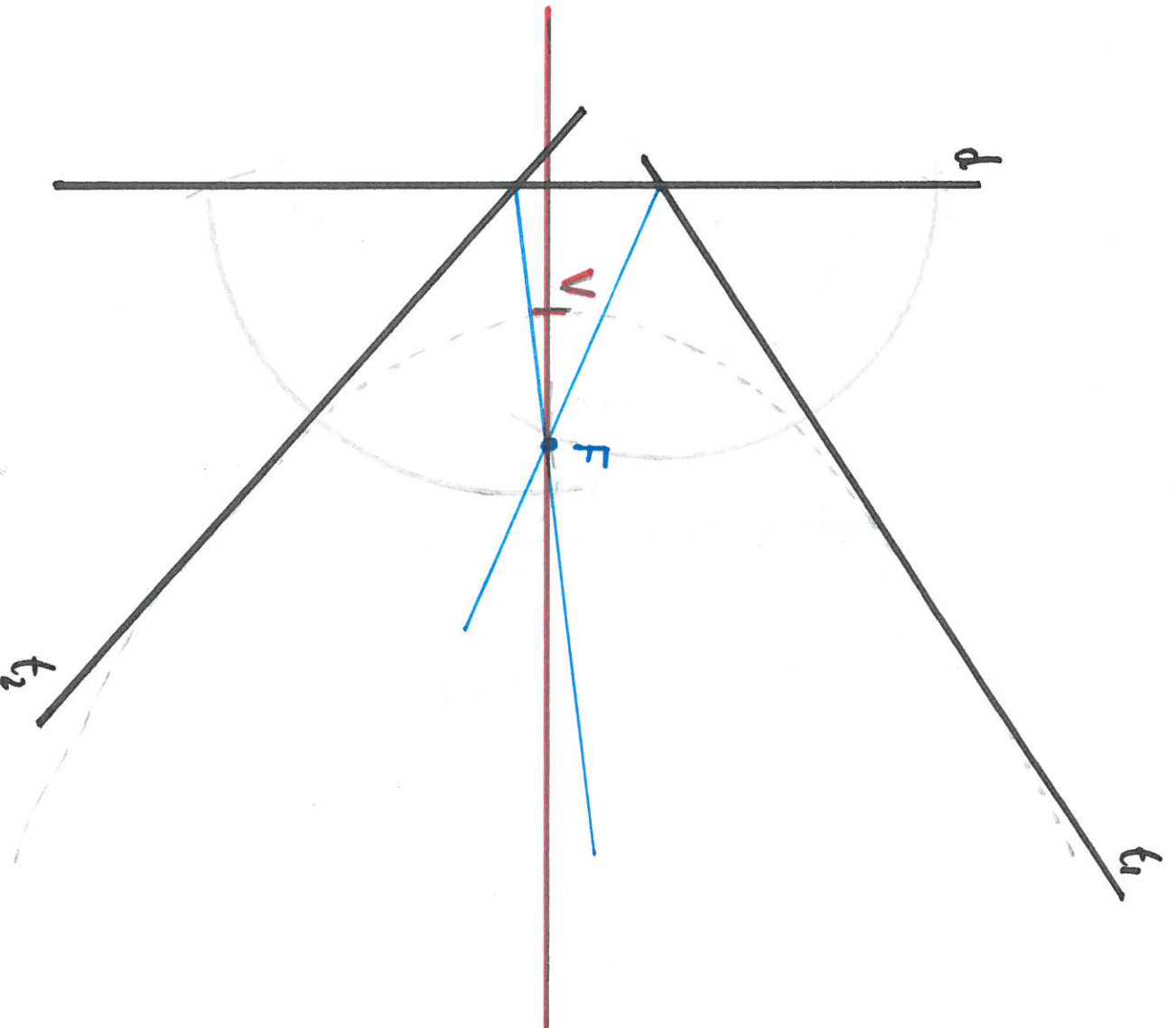

2) FOCO

PUNTO DE LA CURVA

TANGENTE

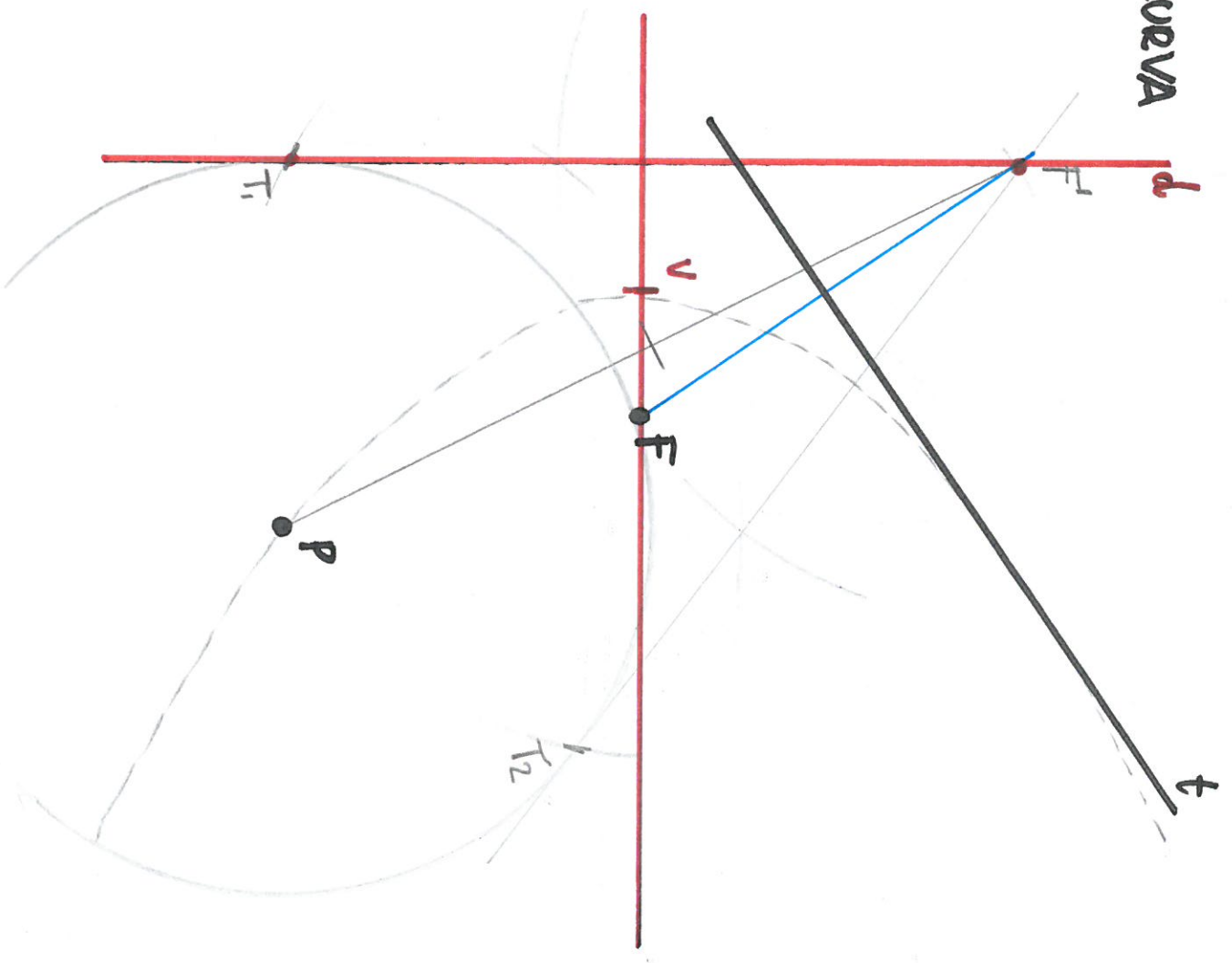

3) DIRECTRIZ

PUNTO DE LA CURVA

TANGENTE

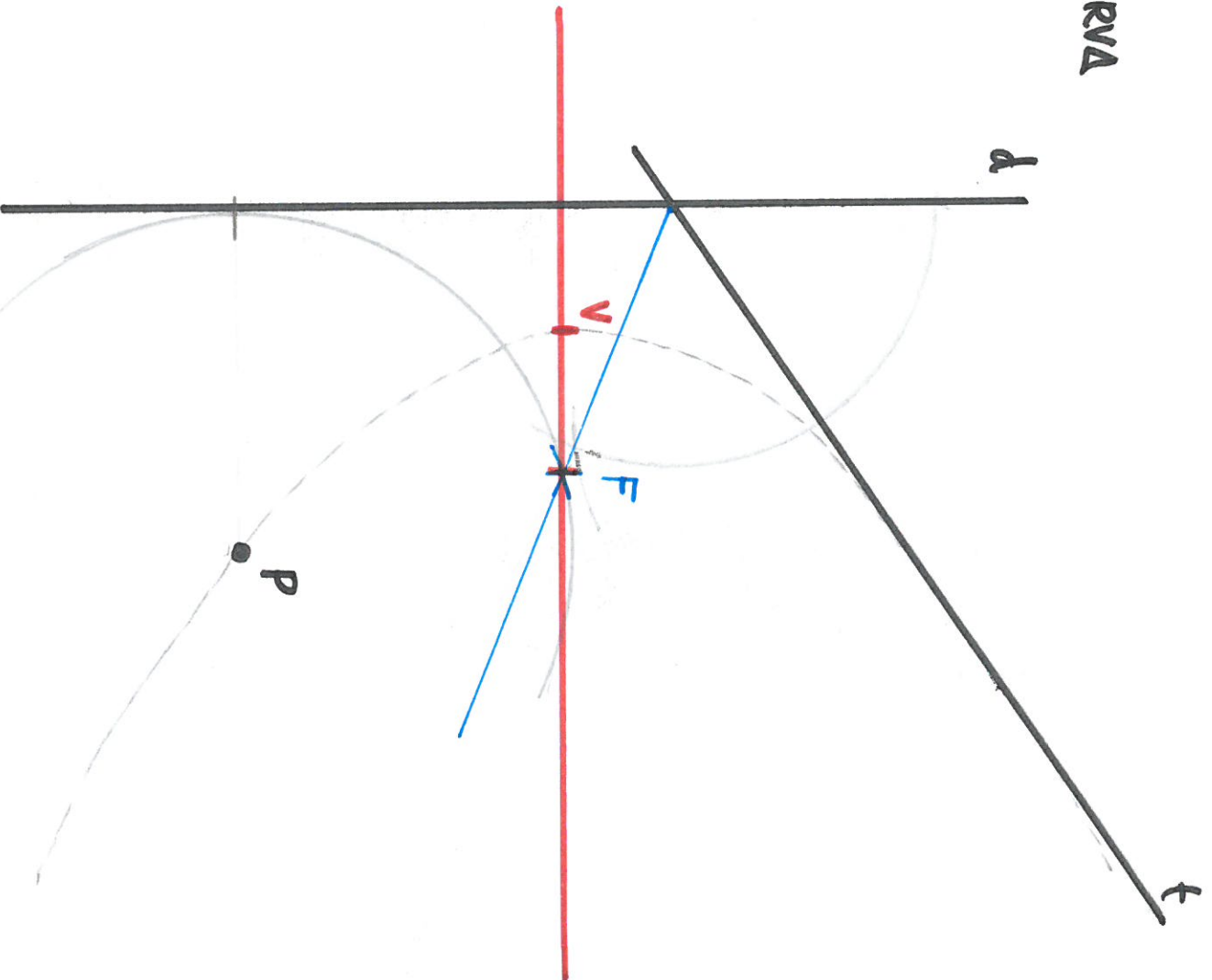

4) 2 TANGENTES
Y SUS PTS. DE TANGENCIA

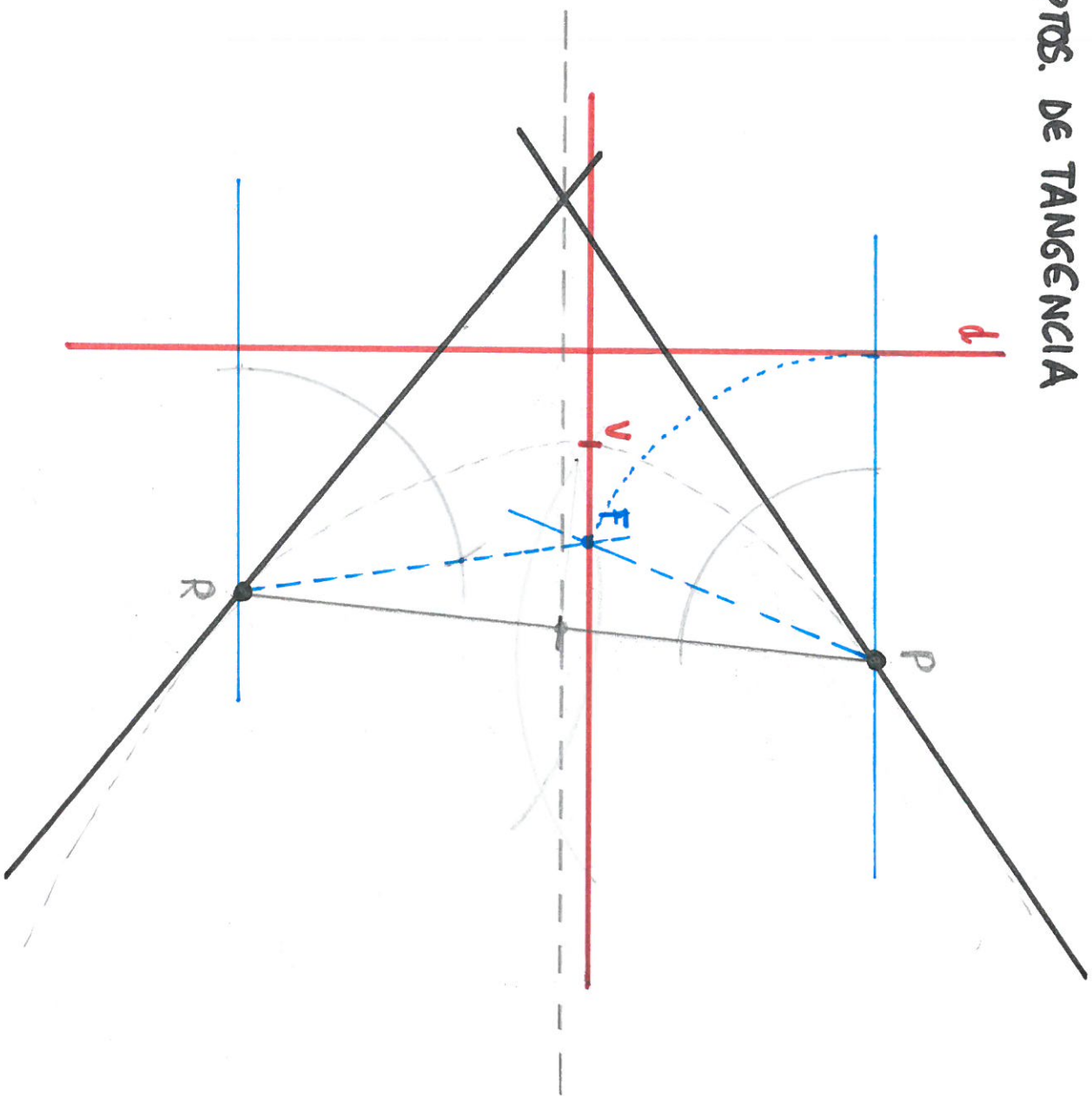

HIPÉRBOLAS

RECTA TANGENTE A LA HIPÉRBOLA POR UN PUNTO DADO

①

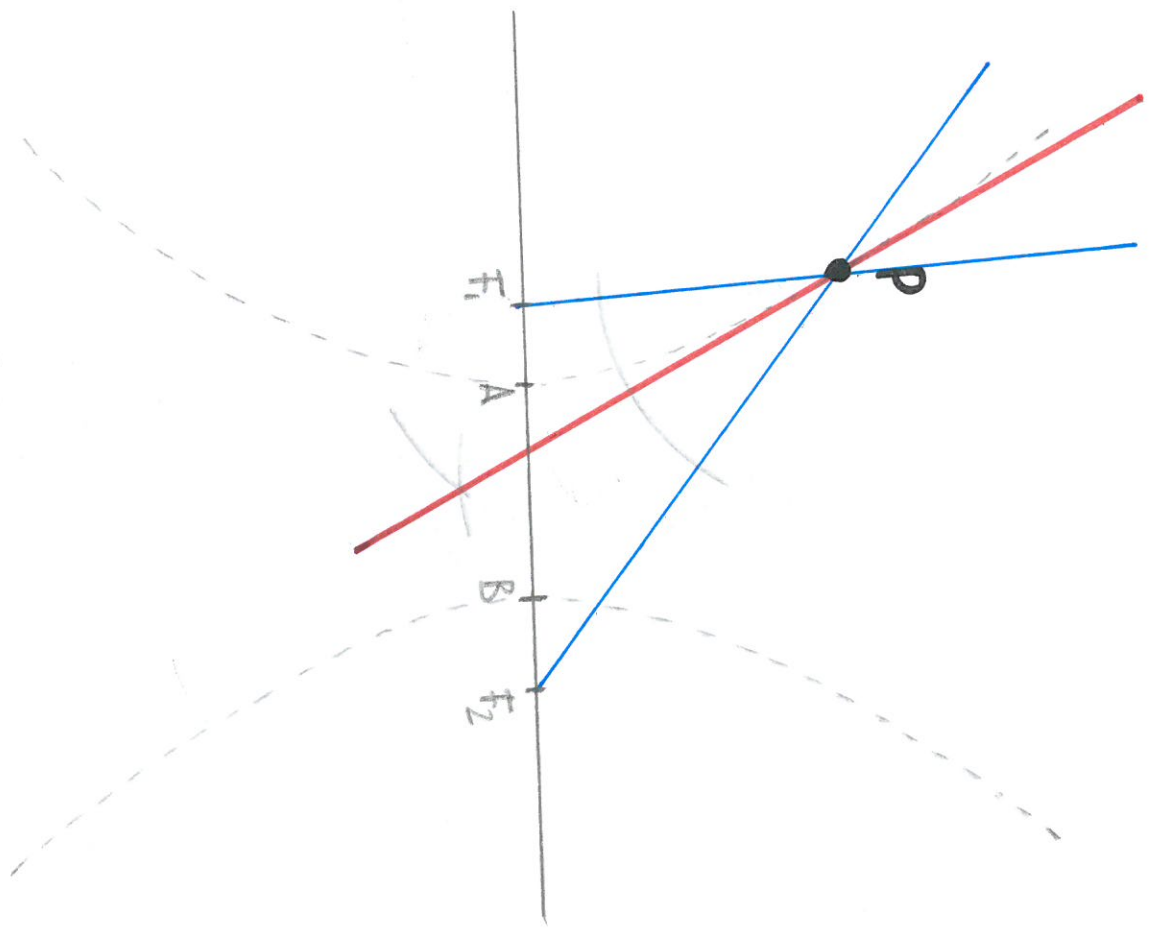

- TG. DESDE UN PUNTO EXTERIOR -

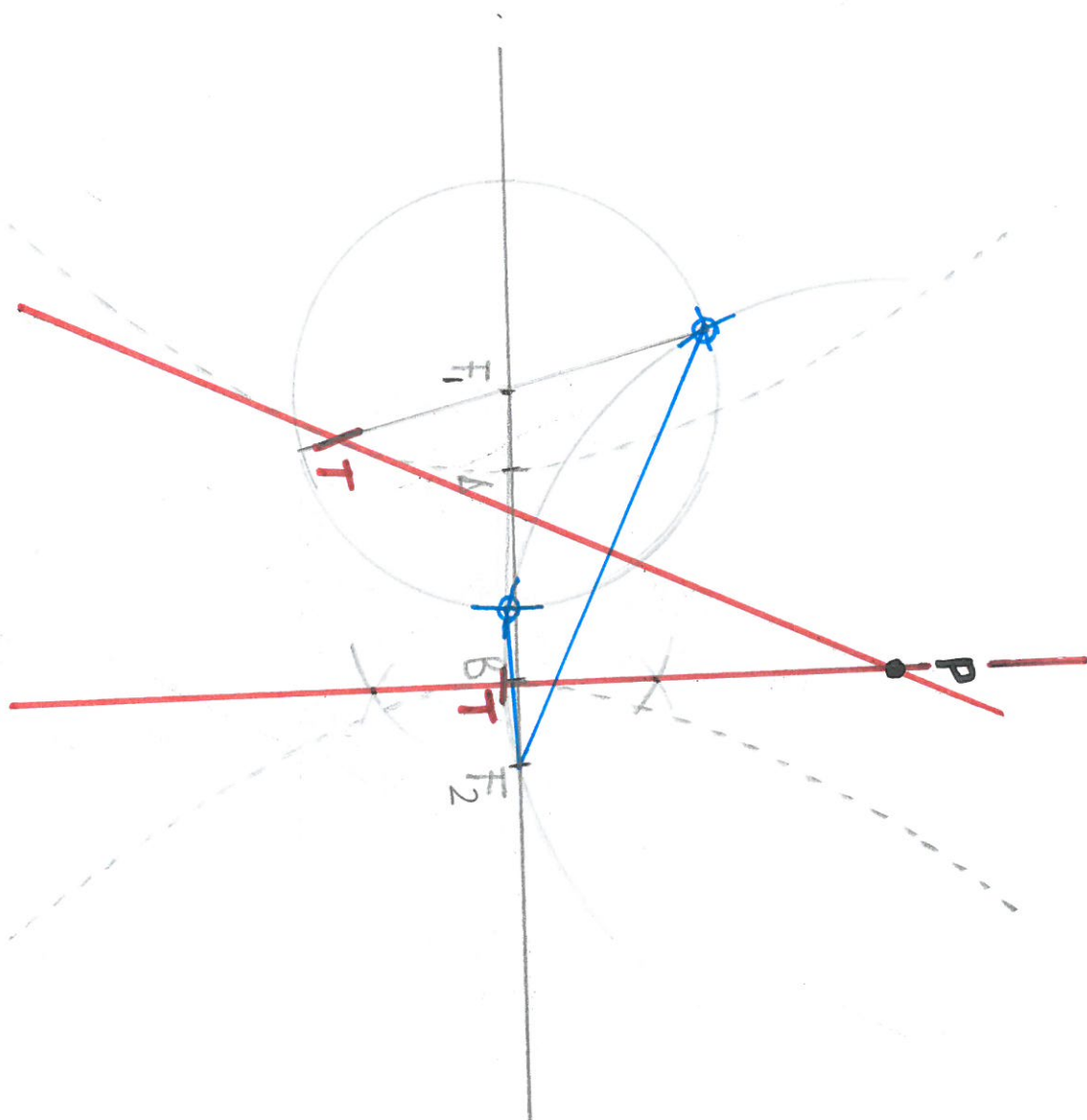

T6. DADA UNA DIRECCIÓ

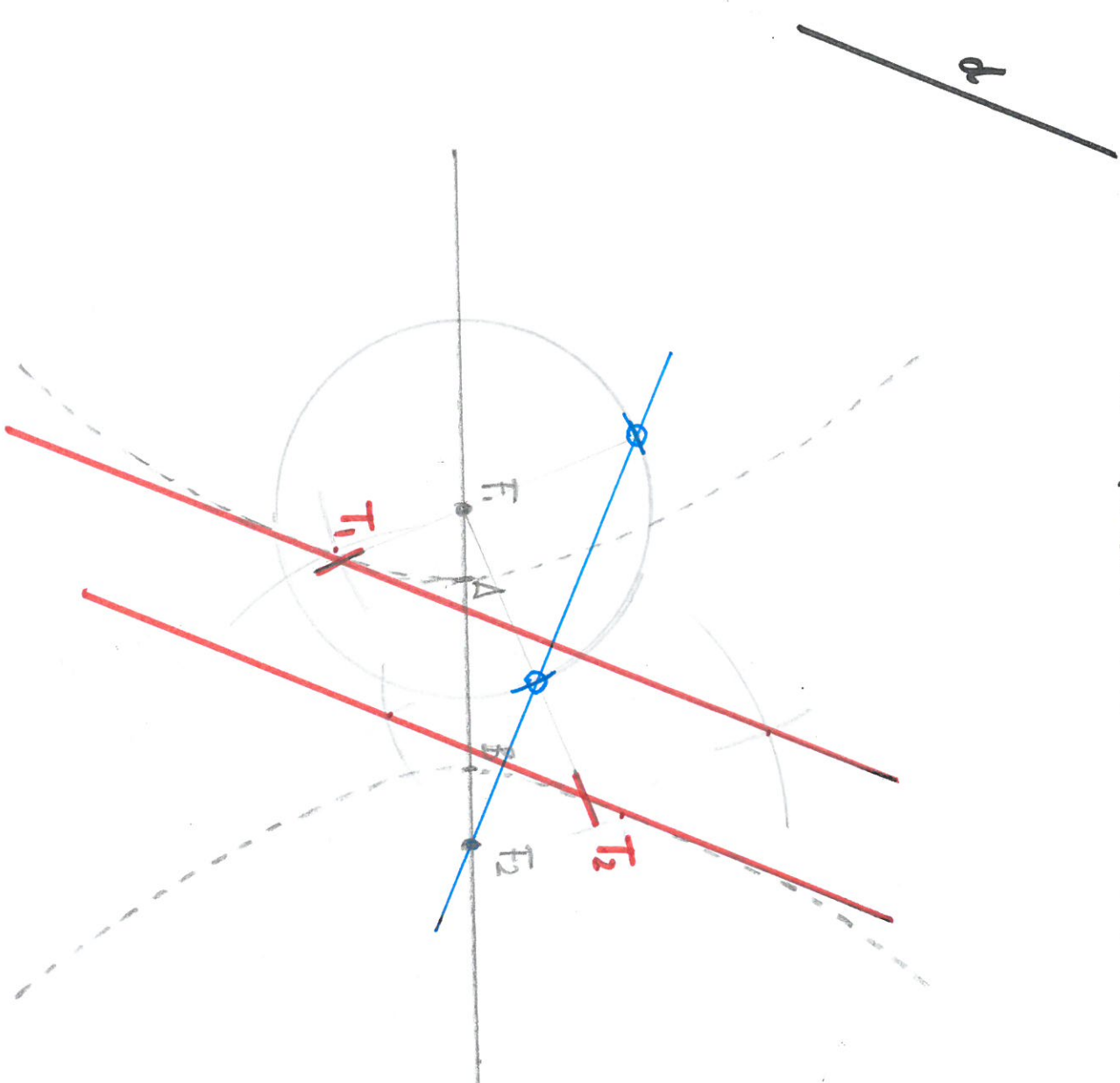

— CONSTRUCCIONES A PARTIR DE
RECTAS TANGENTES —

1) FOCOS

TANGENTE

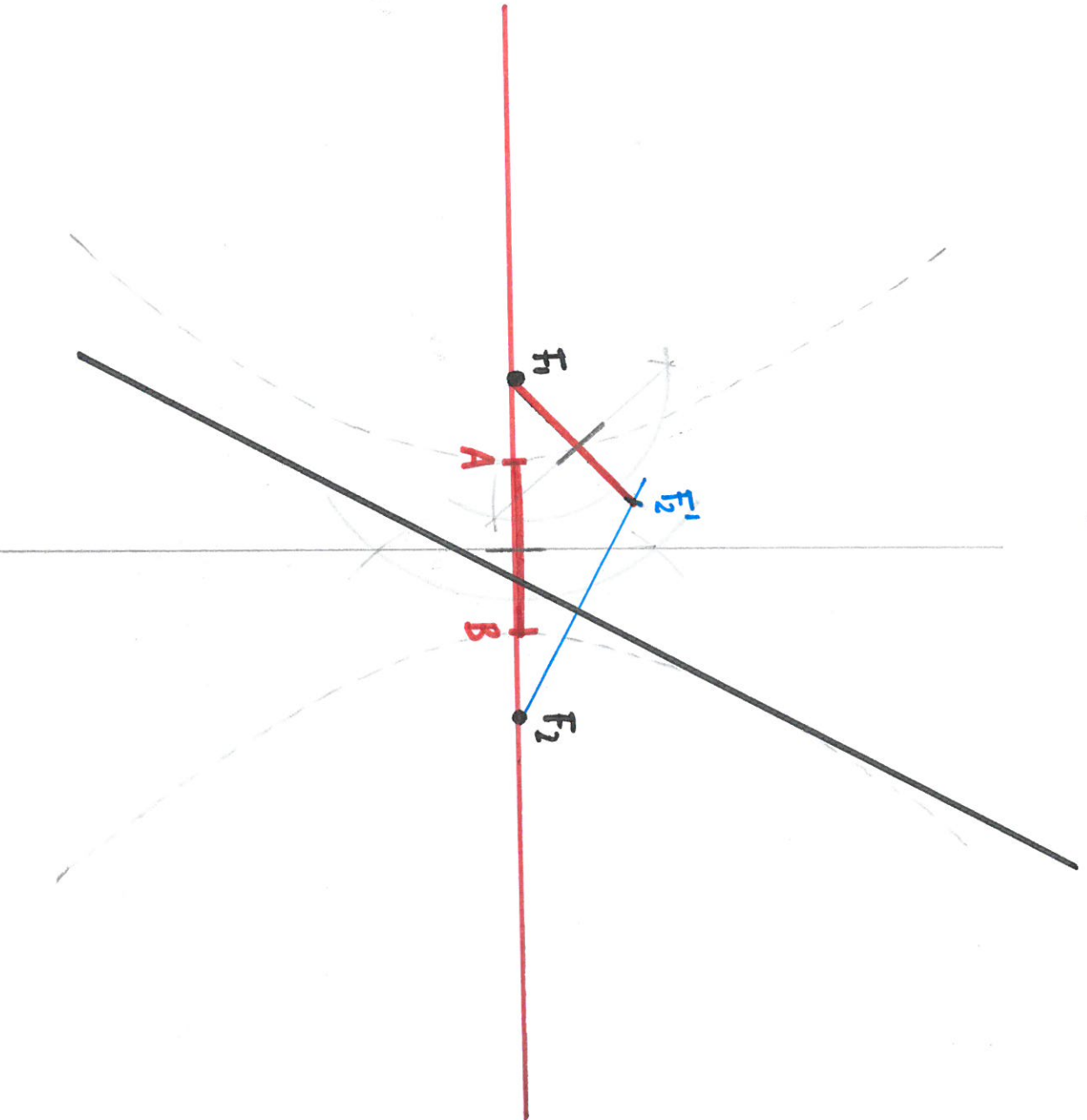

2) FOCO

3 TANGENTES

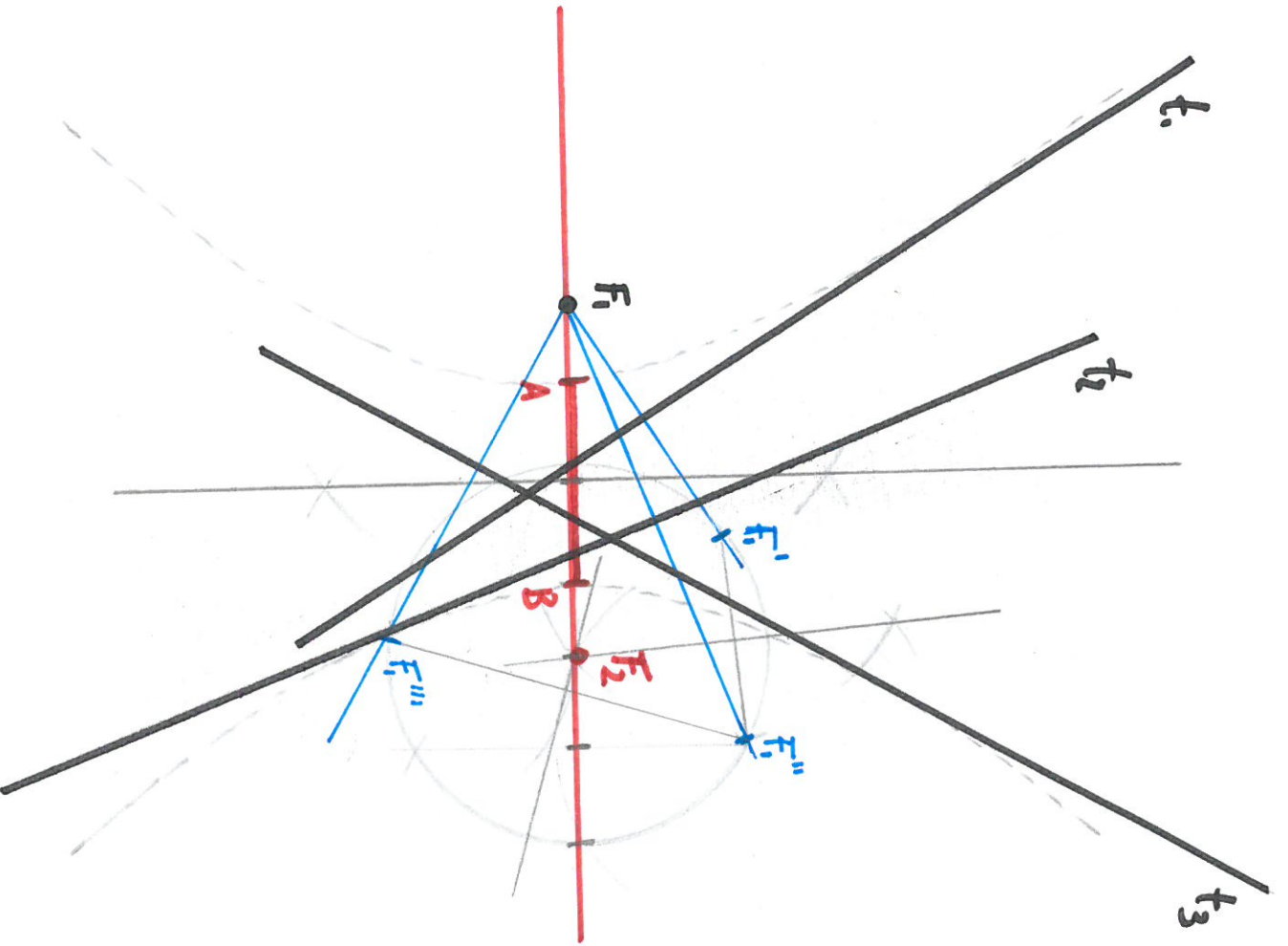

3) EJE AB

TANGENTE

